

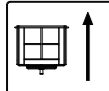

ZWEIWEG

HUBMEISTER Hubarbeitsbühnen auf Multicar
HUBMEISTER aerial platforms at Multicar

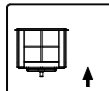
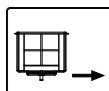
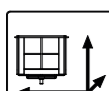
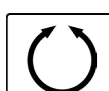
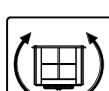
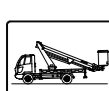
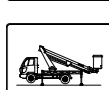

HUBMEISTER HM 9 T

-  **Arbeitshöhe ***
Working height *
8,90 m
-  **Standhöhe ***
Stand height *
6,90 m
-  **Seitliche Reichweite * / ****
Lateral range * / **
5,60 m
-  **Arbeitskorbgröße**
Work basket size
1,40 x 0,70 x 1,10 m
1,60 x 0,80 x 1,10 m (optional)
-  **Schwenkbereich achsabgestützt**
Swivel range axle supported
400°
-  **Korbdrehung**
Basket rotation
-
-  **Fahrzeuglänge / -höhe ***
Vehicle length / height *
6,30 m / 2,20 m
-  **Zulässige Aufstellneigung ***
Permissible inclination *
10°

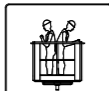



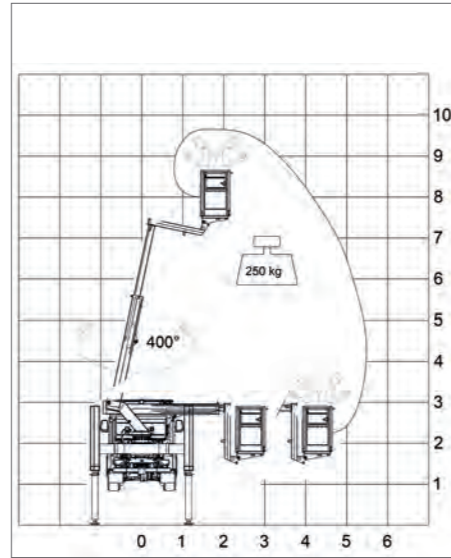

-  **Zulässiges Gesamtgewicht ***
Permissible gross weight *
> 3500 kg
-  **Traglast / Personenzahl***
Load capacity / number of persons*
250 kg / 2

* In Abhängigkeit vom Trägerfahrzeug
According to carrier vehicle
** In Abhängigkeit von der Traglast
According to load capacity

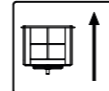
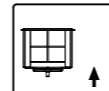
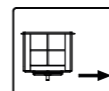

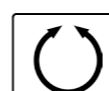
Weitere Arbeitsbühnen können nach Kundenvorgaben – nicht nur für den Straßeneinsatz – projiziert, konstruiert und produziert werden.

HUBMEISTER HM 16 TK

-  **Arbeitshöhe ***
Working height *
16,50 m
-  **Standhöhe ***
Stand height *
14,50 m
-  **Seitliche Reichweite * / ****
Lateral range * / **
11,50 m
-  **Arbeitskorbgröße**
Work basket size
1,40 x 0,70 x 1,10 m
1,60 x 0,80 x 1,10 m (optional)
-  **Schwenkbereich abgestützt**
Swivel range supported
500°
-  **Korbdrehung**
Basket rotation
2x 90°
-  **Fahrzeuglänge / -höhe ***
Vehicle length / height *
6,50 m / 3,22 m
-  **Zulässige Aufstellneigung ***
Permissible inclination *
5°

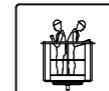
-  **Zulässiges Gesamtgewicht ***
Permissible gross weight *
> 3500 kg
-  **Traglast / Personenzahl***
Load capacity / number of persons*
250 kg / 2

* In Abhängigkeit vom Trägerfahrzeug
According to carrier vehicle
** In Abhängigkeit von der Traglast
According to load capacity

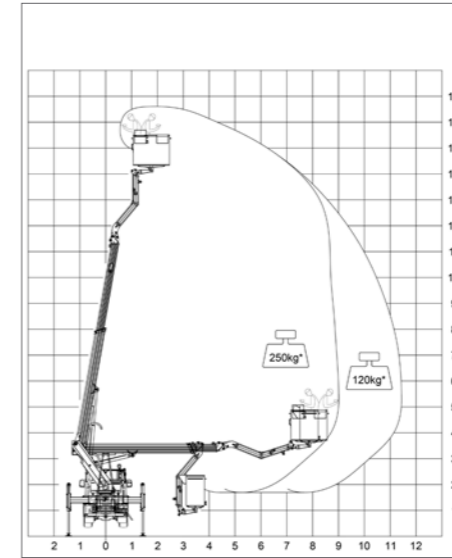

Further platforms may be developed, designed and manufactured according to customers' specifications – not only for road operation.

HUBMEISTER HM 12 TK / HM 14 TK

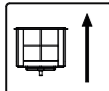
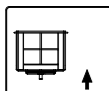
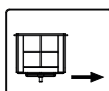
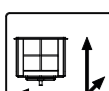
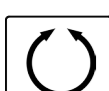
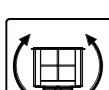
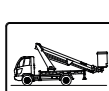
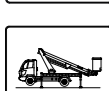
-  **Arbeitshöhe ***
Working height *
12,20 m / 14 m
-  **Standhöhe ***
Stand height *
10,20 m / 12 m
-  **Seitliche Reichweite * / ****
Lateral range * / **
8,10 m / 9 m
-  **Arbeitskorbgröße**
Work basket size
1,40 x 0,70 x 1,10 m
1,60 x 0,80 x 1,10 m (optional)
-  **Schwenkbereich abgestützt**
Swivel range supported
400° – 500°
-  **Korbdrehung**
Basket rotation
+/- 90°
-  **Fahrzeuglänge / -höhe ***
Vehicle length / height *
6,80 m / 3,20 m
-  **Zulässige Aufstellneigung ***
Permissible positioning inclination *
5°

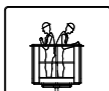



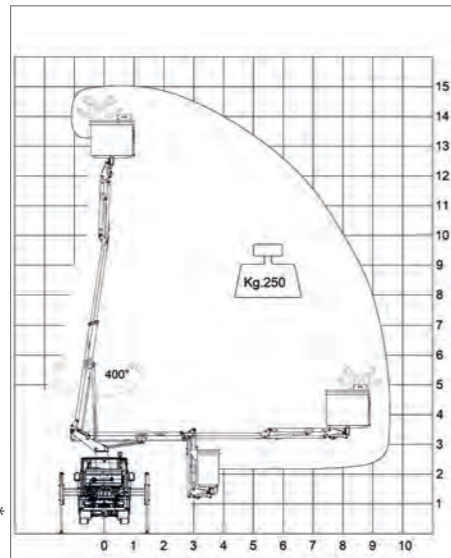

-  **Zulässiges Gesamtgewicht ***
Permissible gross weight *
> 3500 kg
-  **Traglast / Personenzahl**
Load capacity / number of persons
200 kg / 2

* In Abhängigkeit vom Trägerfahrzeug
According to carrier vehicle
** In Abhängigkeit von der Traglast
According to load capacity

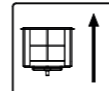
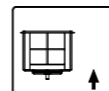
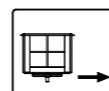

Weitere Arbeitsbühnen können nach Kundenvorgaben – nicht nur für den Straßeneinsatz – projiziert, konstruiert und produziert werden.

HUBMEISTER HM 22 T

-  **Arbeitshöhe ***
Working height *
22,60 m
-  **Standhöhe ***
Stand height *
20,60 m
-  **Seitliche Reichweite * / ****
Lateral range * / **
13,20 m
-  **Arbeitskorbgröße**
Work basket size
1,40 x 0,70 x 1,10 m
1,60 x 0,80 x 1,10 m (optional)
-  **Schwenkbereich abgestützt**
Swivel range supported
500°
-  **Korbdrehung**
Basket rotation
2x 90°
-  **Fahrzeuglänge / -höhe ***
Vehicle length / height *
7,00 m / 3,25 m
-  **Zulässige Aufstellneigung ***
Permissible inclination *
5°

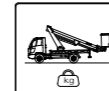
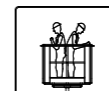
-  **Zulässiges Gesamtgewicht ***
Permissible gross weight *
> 3500 kg
-  **Traglast / Personenzahl***
Load capacity / number of persons*
250 kg / 2

* In Abhängigkeit vom Trägerfahrzeug
According to carrier vehicle
** In Abhängigkeit von der Traglast
According to load capacity

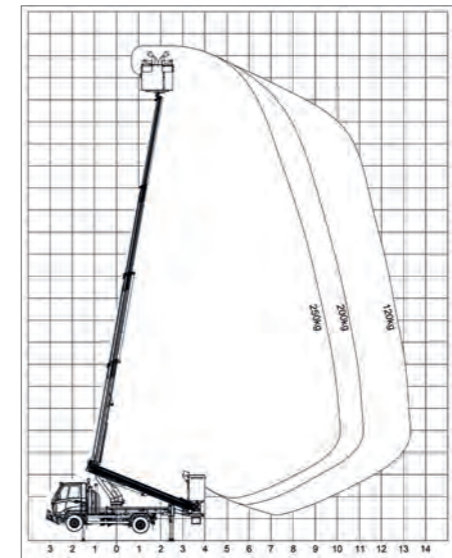

Further platforms may be developed, designed and manufactured according to customers' specifications – not only for road operation.

Weitere Produkte – Bahntechnik

Further products – Railway technology



ZWEIWEG International GmbH & Co. KG

Oberbüscherhof 50
42799 Leichlingen
Germany
Telefon +49 2174 7909-0
info@zweiweg.de
www.zagro-group.com

